

**CONNETTORI MICROFONICI Ø16 MM**

**Connettore maschio volante ø16 mm**

Codice Adimpex: **GLT10303-R**

CONNET MS MIC 8042-3 03P

Serie:8042

p/n:8042-3 MIC MALE 03P

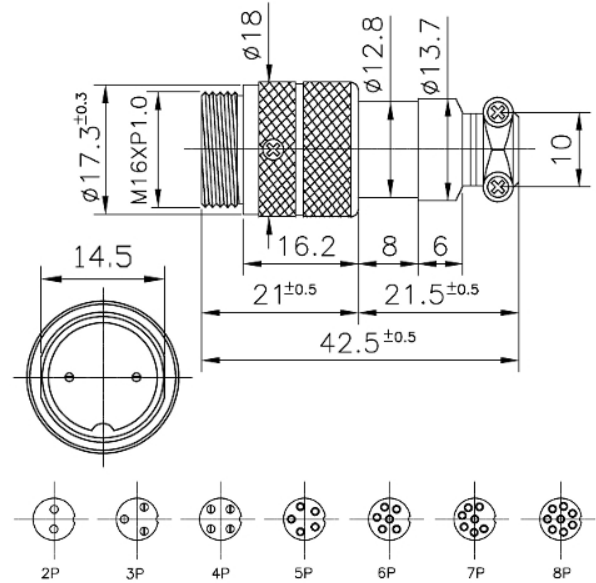

**Codice Adimpex**

**GLT1030x**

**n° Contatti**

*x (2 ÷ 8)*

**CARATTERISTICHE**

- Portata: 5A 125V/250V
- Rigidità dielettrica: 1000V AC per 1 minuto
- Resistenza di isolamento: 100MΩ min.
- Corpo: lega di zinco nichelato
- Pin: ottone, nichelato
- Isolante: bachelite

**FEATURES**

- *Rating: 5A 125V/250V*
- *Withstanding voltage: 1000V AC for 1 minute*
- *Insulation resistance: 100MΩ min.*
- *Housing: zinc alloy, nickel plated*
- *Pin: brass, nickel plated*
- *Insulator: bakelite*