

CONNETTORI MICROFONICI Ø16 MM

Connettore femmina volante ø16 mm

Codice Adimpex: **GLT10103-R**

CONNET FM MIC 8040-3 03P

Serie:8040

p/n:8040-3 MIC FEMALE 3P

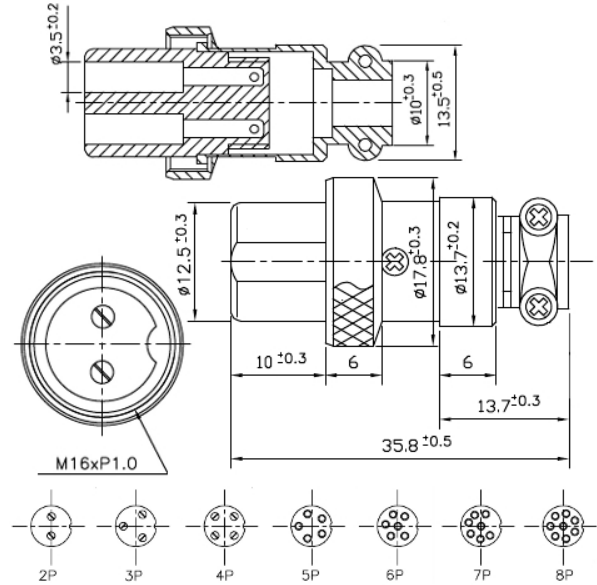

Codice Adimpex

GLT1010x

n. contatti

x (2 ÷ 8)

CARATTERISTICHE

- Portata: 5A 125V/250V
- Rigidità dielettrica: 1000V AC per 1 minuto
- Resistenza di isolamento: 100MΩ min.
- Corpo: lega di zinco nichelato
- Pin: ottone, nichelato
- Isolante: bachelite

FEATURES

- *Rating: 5A 125V/250V*
- *Withstanding voltage: 1000V AC for 1 minute*
- *Insulation resistance: 100MΩ min.*
- *Housing: zinc alloy, nickel plated*
- *Pin: brass, nickel plated*
- *Insulator: bakelite*