

Spina UL-CSA con cavo tondo

Codice Adimpex: **GJ148020-R**

C.ULR-3w16SJT spA A128-N/200

Serie:KE-02

p/n:KE-02 SJT-3 AWG16/3C

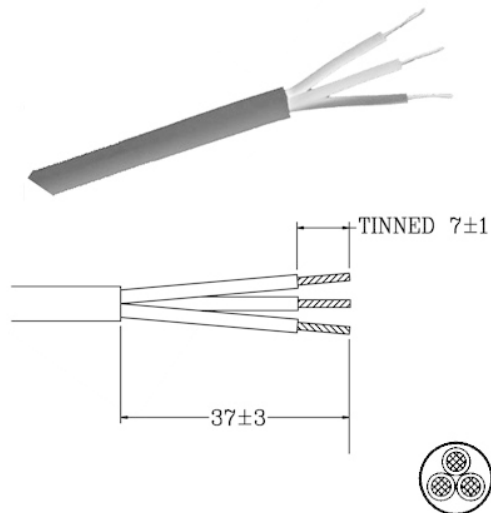

Codice Adimpex	Tipo	Portata	Tipo	Cavo Sezione	Lunghezza	Colore
GJ145025	A122	10A 125V	SJT-3 105°	AWG 18 x 3	2.5 m	Nero
GJ148020	A128	13A 125V	SJT-3 105°	AWG 16 x 3	2.0 m	Nero

