

Induttori e toroidi

SERIE DBS135 68UH 1.4A

IND. SMD DBS135-680M 68uH 1.4A

Codice Adimpex: **FJ124068CO**

P/N: **DBS135NP-680M**

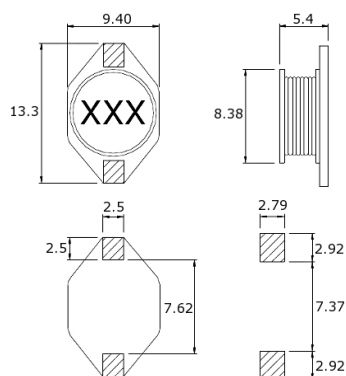

Caratteristiche Tecniche:

Dimensione (mm):	12.8x9.3 H5.4
L (uH):	68
Tipologia:	Induttori SMD
Schermatura:	NO