

Induttori e toroidi

SERIE DA75 150UH 0.58A

IND. SMD DA75-151K 150uH 0.58A

Codice Adimpex: **FJ026115CO**

P/N: **DA75NP-151K**

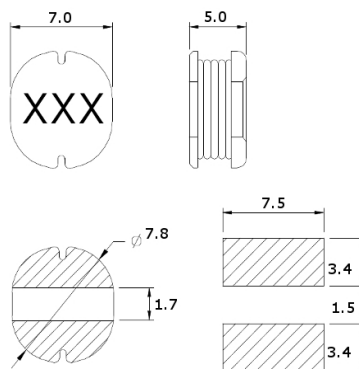

Caratteristiche Tecniche:

L (uH):	150
Dimensione (mm):	7.0x7.8 H5.3
Tipologia:	Induttori SMD
Schermatura:	NO