

INDUTTORI DI BLOCCO RADIALI

Serie CD2810

Codice Adimpex: **FI088168-R**

I.RD CD2810-681K 680uH 0.38A **

p/n:CD2810-681KUS 680uH

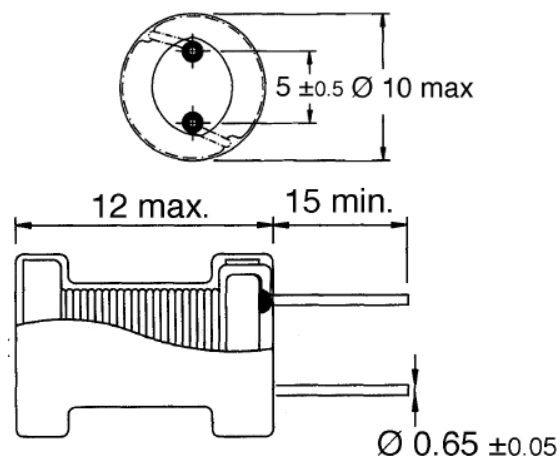

Codice Adimpex	L (μ H)	DCR (Ω)max.	DCI (A)max.	Codice Adimpex	L (μ H)	DCR (Ω)max.	DCI (A)max.	Codice Adimpex	L (μ H)	DCR (Ω)max.	DCI (A)max.
FI088.10	1.0	0.010	10.0	FI088112	120	0.30	0.84	FI088247	4700	9.00	0.14
FI088.15	1.5	0.012	8.50	FI088115	150	0.35	0.75	FI088253	5300	9.50	0.13
FI088.22	2.2	0.013	6.50	FI088118	180	0.39	0.69	FI088256	5600	10.0	0.12
FI088.33	3.3	0.016	5.50	FI088122	220	0.49	0.64	FI088268	6800	13.0	0.10
FI088.47	4.7	0.020	4.30	FI088127	270	0.59	0.57	FI088282	8200	15.0	0.095
FI088.68	6.8	0.023	3.70	FI088133	330	0.79	0.54	FI088310	10000	17.0	0.070
FI088.82	8.2	0.026	3.50	FI088139	390	0.87	0.48	FI088312	12000	19.0	0.060
FI088010	10	0.030	3.00	FI088147	470	0.95	0.46	FI088315	15000	28.0	0.050
FI088012	12	0.033	2.60	FI088156	560	1.20	0.41	FI088318	18000	31.0	0.045
FI088015	15	0.040	2.30	FI088168	680	1.60	0.38	FI088322	22000	36.0	0.030
FI088018	18	0.044	2.20	FI088182	820	1.80	0.35	FI088327	27000	42.0	0.027
FI088022	22	0.056	2.00	FI088210	1000	2.90	0.29	FI088330	30000	54.0	0.020
FI088027	27	0.077	1.70	FI088212	1200	2.50	0.28	FI088333	33000	56.0	0.015
FI088033	33	0.087	1.60	FI088215	1500	2.70	0.25	FI088339	39000	87.0	0.010
FI088039	39	0.098	1.50	FI088218	1800	3.20	0.23	FI088347	47000	100	0.008
FI088047	47	0.110	1.40	FI088222	2200	3.50	0.20	FI088356	56000	114	0.004
FI088056	56	0.130	1.30	FI088225	2500	4.00	0.18	FI088360	60000	125	0.004
FI088068	68	0.140	1.20	FI088227	2700	4.80	0.17	FI088368	68000	128	0.004
FI088082	82	0.190	1.10	FI088233	3300	5.40	0.16	FI088382	82000	180	0.003
FI088110	100	0.230	0.91	FI088239	3900	6.00	0.15	FI088410	100000	210	0.003

Tolleranza: $\pm 20\%$ (M) - $1.0 \leq L \leq 8.2$
 $\pm 10\%$ (K) - $L \geq 10$

CARATTERISTICHE

- Core: ferrite
- Filo: rame smaltato
- Terminali: rame stagnato
- Rivestimento: guaina termorestringente
- DCI max.: valore per cui si ha una riduzione del 10%

FEATURES

- Core: ferrite
- Wire: polyurethane enameled copper wire
- Lead wire: soldered copper wire
- Tube: shrinkable tube
- DCI max.: value when the inductance decreases

dell'induttanza

of 10%