

Induttori e toroidi

RADIALE SERIE CD2810 330UH 0.66A

I.RD CW8A-331K 330uH 0.66A

Codice Adimpex: **FI088133CO**

P/N: **CW8ANP-331K**

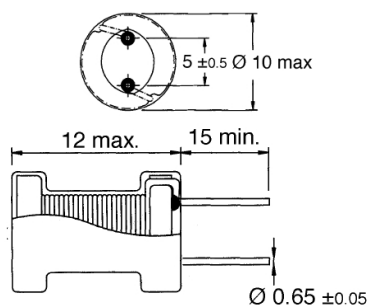

Caratteristiche Tecniche:

L (uH):	330
Pitch (mm):	4.8 e 5.0
Tipologia:	Induttori di blocco radiali PTH
Dimensione (mm):	Ø10 H12.0