

Induttori e toroidi

RADIALE SERIE CD2810 220UH 0.78A

I.RD CW8A-221K 220uH 0.78A

Codice Adimpex: **FI088122CO**

P/N: **CW8ANP-221K**

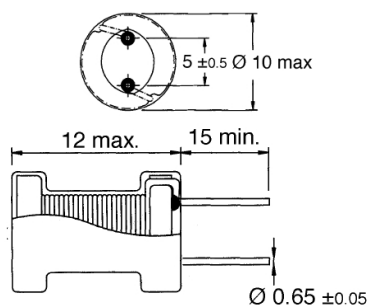

Caratteristiche Tecniche:

L (uH):	220
Pitch (mm):	4.8 e 5.0
Tipologia:	Induttori di blocco radiali PTH
Dimensione (mm):	Ø10 H12.0