

Induttori e toroidi

RADIALE SERIE CD2810 22UH 2.5A

I.RD CW8A-220K 22uH 2.5A

Codice Adimpex: **FI088022CO**

P/N: **CW8ANP-220K**

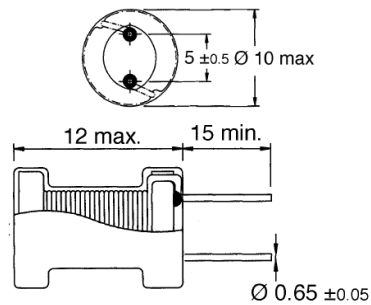
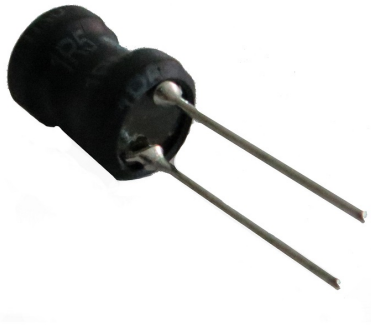

Caratteristiche Tecniche:

L (uH):	22
Pitch (mm):	4.8 e 5.0
Tipologia:	Induttori di blocco radiali PTH
Dimensione (mm):	Ø10 H12.0