

Induttori e toroidi

**RADIALE SERIE CD2810 15UH 2.8A**

I.RD CW8A-150K 15uH 2.8A

Codice Adimpex: **FI088015CO**

P/N: **CW8ANP-150K**

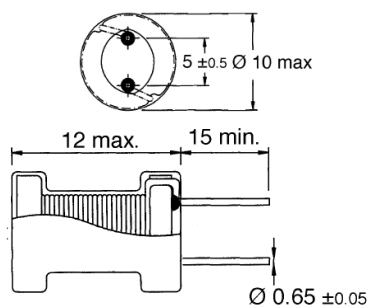

Caratteristiche Tecniche:

L (uH):	15
Pitch (mm):	4.8 e 5.0
Tipologia:	Induttori di blocco radiali PTH
Dimensione (mm):	Ø10 H12.0