

Induttori e toroidi

**RADIALE SERIE CWCD 470UH 1.2A**

IND.RAD.CWCD-471KNP 470uH 1.2A

Codice Adimpex: **FH100147-R**

P/N: **CWCD-471K-NP**

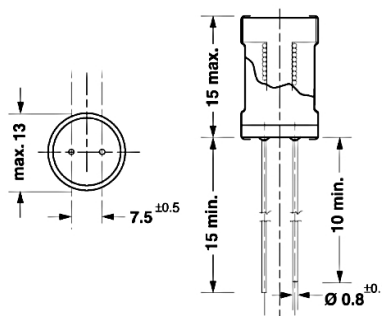
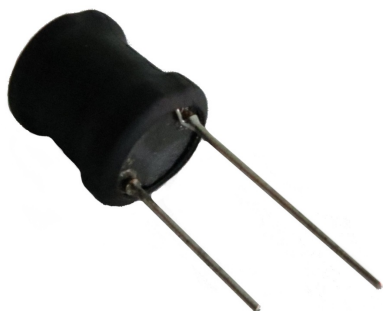

Caratteristiche Tecniche:

L (uH):	470
Pitch (mm):	7.5
Tipologia:	Induttori di blocco radiali PTH
Dimensione (mm):	Ø13 H15.0