

Induttori e toroidi

RADIALE SERIE CWCD 47UH 4.1A

IND.RAD.CWCD-470KNP 47uH 4.1A

Codice Adimpex: **FH100047-R**

P/N: **CWCD-470K-NP**

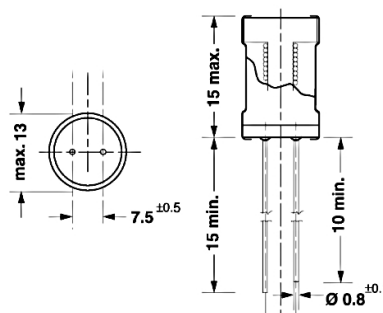
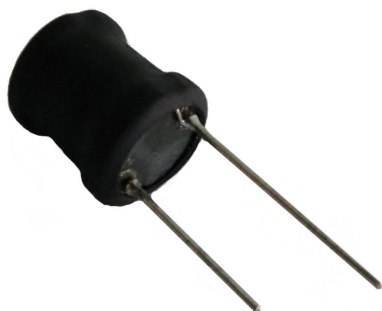

Caratteristiche Tecniche:

L (uH):	47
Pitch (mm):	7.5
Tipologia:	Induttori di blocco radiali PTH
Dimensione (mm):	Ø13 H15.0