

Induttori e toroidi

RADIALE SERIE CWCD 22UH 5.4A

IND.RAD.CWCD-220KNP 22uH 5.4A

Codice Adimpex: **FH100022-R**

P/N: **CWCD-220K-NP**

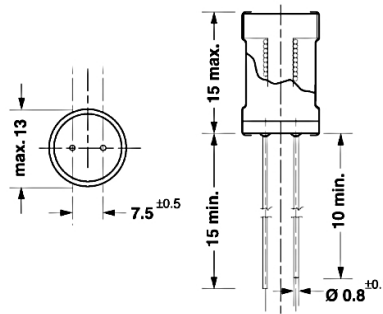
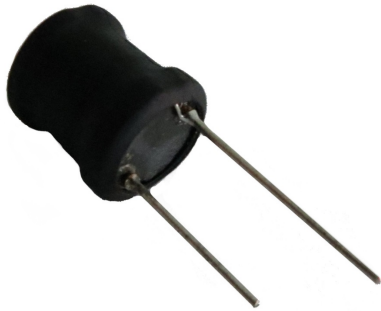

Caratteristiche Tecniche:

L (uH):	22
Pitch (mm):	7.5
Tipologia:	Induttori di blocco radiali PTH
Dimensione (mm):	Ø13 H15.0