

Induttori e toroidi

RADIALE SERIE CWCD 15UH 5.7A

IND.RAD.CWCD-150KNP 15uH 5.7A

Codice Adimpex: **FH100015-R**

P/N: **CWCD-150K-NP**

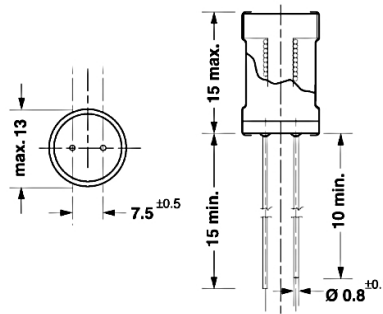
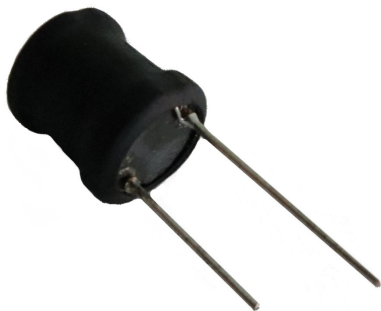

Caratteristiche Tecniche:

L (uH):	15
Pitch (mm):	7.5
Tipologia:	Induttori di blocco radiali PTH
Dimensione (mm):	Ø13 H15.0