

Induttori e toroidi

RADIALE SERIE CWCD 12UH 5.9A

IND.RAD.CWCD-120KNP 12uH 5.9A

Codice Adimpex: **FH100012-R**

P/N: **CWCD-120K-NP**

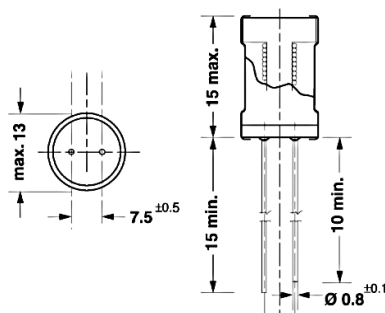
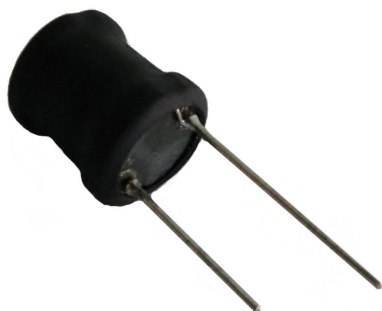

Caratteristiche Tecniche:

L (uH):	12
Pitch (mm):	7.5
Tipologia:	Induttori di blocco radiali PTH
Dimensione (mm):	Ø13 H15.0