

Induttori e toroidi

RADIALE SERIE CWCD 10UH 6.5A

IND.RAD.CWCD-100KNP 10uH 6.5A

Codice Adimpex: **FH100010-R**

P/N: **CWCD-100K-NP**

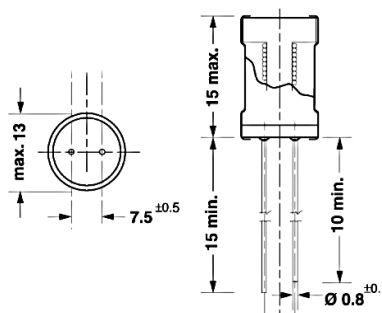
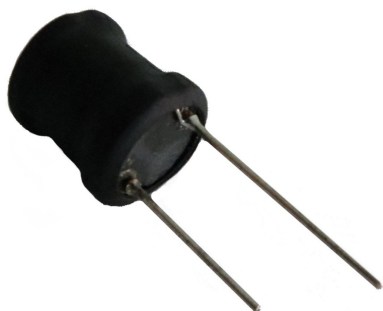

Caratteristiche Tecniche:

L (uH):	10
Pitch (mm):	7.5
Tipologia:	Induttori di blocco radiali PTH
Dimensione (mm):	Ø13 H15.0