

Induttori e toroidi

RADIALE SERIE CW57 680UH 150MA

IND RD CW57-681KNP 680uH 150mA

Codice Adimpex: **FH057168-R**

P/N: **CW57-681K-NP**

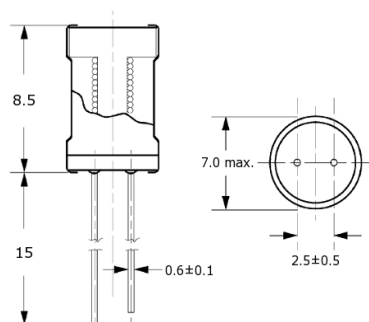

Caratteristiche Tecniche:

Pitch (mm):	2.5
L (uH):	680
Tipologia:	Induttori di blocco radiali PTH
Dimensione (mm):	Ø7 H8.5