

Induttori e toroidi

RADIALE SERIE CW57 470UH 180MA

IND RD CW57-471KNP 470uH 180mA

Codice Adimpex: **FH057147-R**

P/N: **CW57-471K-NP**

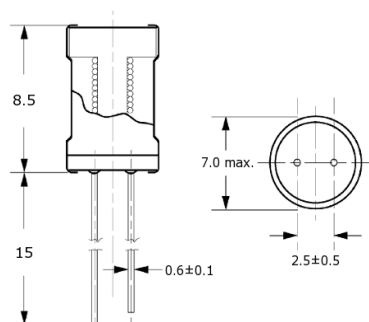

Caratteristiche Tecniche:

Pitch (mm):	2.5
L (uH):	470
Tipologia:	Induttori di blocco radiali PTH
Dimensione (mm):	Ø7 H8.5