

INDUTTORI DI BLOCCO RADIALI

Serie CW57

Codice Adimpex: **FH057015-R**

IND RD CW57-150KNP 15uH 1300mA

p/n: CW57-150K-NP

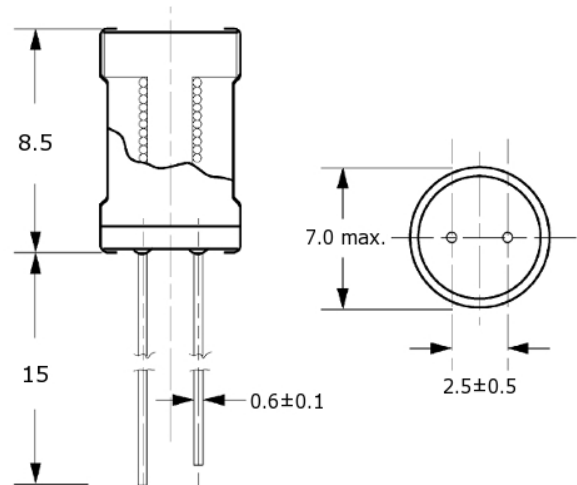
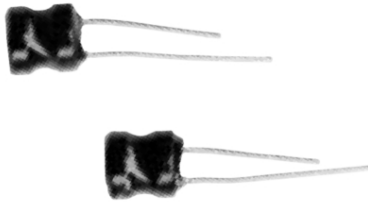

Codice Adimpex	L (μH)	DCR (Ω)max.	DCI (mA)max.	Codice Adimpex	L (μH)	DCR (Ω)max.	DCI (mA)max.	Codice Adimpex	L (μH)	DCR (Ω)max.	DCI (mA)max.
FH057.10	1.0	0.013	5600	FH057039	39	0.21	800	FH057215	1500	5.2	110
FH057.12	1.2	0.015	4800	FH057047	47	0.25	750	FH057218	1800	6.8	100
FH057.15	1.5	0.016	4200	FH057056	56	0.33	700	FH057222	2200	7.9	90
FH057.18	1.8	0.018	3800	FH057068	68	0.41	620	FH057227	2700	9.8	80
FH057.22	2.2	0.020	3400	FH057082	82	0.46	580	FH057233	3300	12	70
FH057.27	2.7	0.024	3200	FH057110	100	0.38	400	FH057239	3900	15	65
FH057.33	3.3	0.026	3000	FH057112	120	0.43	380	FH057247	4700	17	55
FH057.39	3.9	0.030	2600	FH057115	150	0.55	330	FH057256	5600	22	52
FH057.47	4.7	0.036	2300	FH057118	180	0.63	310	FH057268	6800	25	48
FH057.56	5.6	0.041	2100	FH057122	220	0.73	280	FH057282	8200	29	44
FH057.68	6.8	0.048	1900	FH057127	270	0.88	260	FH057310	10000	33	40
FH057.82	8.2	0.060	1800	FH057133	330	1.10	220	FH057312	12000	44	36
FH057010	10	0.065	1700	FH057139	390	1.40	200	FH057315	15000	52	32
FH057012	12	0.081	1500	FH057147	470	1.70	180	FH057318	18000	69	28
FH057015	15	0.097	1300	FH057156	560	2.00	170	FH057322	22000	80	26
FH057018	18	0.110	1200	FH057168	680	2.30	150	FH057327	27000	94	22
FH057022	22	0.130	1000	FH057182	820	2.60	140	FH057333	33000	138	20
FH057027	27	0.150	950	FH057210	1000	3.20	130	FH057339	39000	156	18
FH057033	33	0.160	880	FH057212	1200	4.20	120	FH057347	47000	178	16

Tolleranza: $\pm 20\%$ (M) - $1.0 \leq L \leq 8.2$
 $\pm 10\%$ (K) - $L \geq 10$

CARATTERISTICHE

- Core: ferrite
- Filo: rame smaltato
- Terminali: rame stagnato
- Rivestimento: guaina termorestringente
- DCI max.: valore per cui si ha una riduzione del 10% dell'induttanza

FEATURES

- Core: ferrite
- Wire: polyurethane enameled copper wire
- Lead wire: soldered copper wire
- Tube: shrinkable tube
- DCI max.: value when the inductance decreases of 10%

