

VARISTORI
Varistore ø20 mm

 Codice Adimpex: **COT50250-R**

VARISTORI TSV-20D391K S 250VAC

Serie:TSV

p/n:TSV-20D391K 250VAC

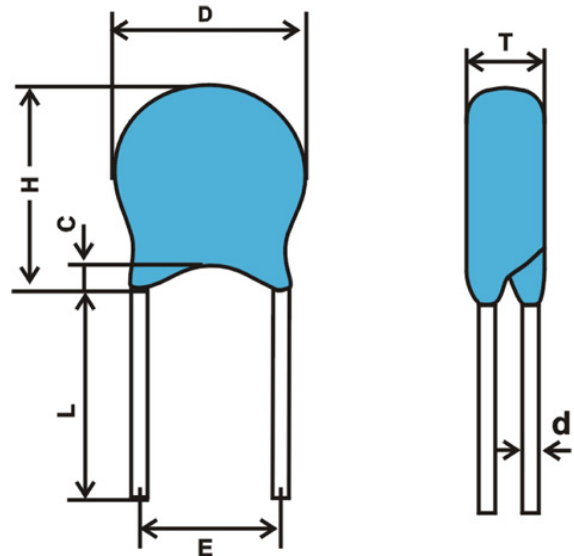

Codice Adimpex	V _{eff} AC rms (V)	V _v @1.0 mA (V)
COT50020	20	33
COT50025	25	39
COT50030	30	47
COT50035	35	56
COT50040	40	68
COT50050	50	82
COT50060	60	100
COT50075	75	120
COT50095	95	150
COT50115	115	180
COT50130	130	200
COT50140	140	220
COT50150	150	240
COT50175	175	270

Codice Adimpex	V _{eff} AC rms (V)	V _v @1.0 mA (V)
COT50190	190	300
COT50210	210	330
COT50230	230	360
COT50250	250	390
COT50275	275	430
COT50300	300	470
COT50320	320	510
COT50350	350	560
COT50385	385	620
COT50420	425	680
COT50460	460	750
COT50485	485	780
COT50510	510	820

CARATTERISTICHE

- Tolleranza: ± 10% (K)
- Temperatura di lavoro: -40°C ÷ +85°C
- Temperatura di immagazzinaggio: -40°C ÷ +125°C
- Confezione: sciolti (standard).

FEATURES

- Tolerance: ± 10% (K)
- Operating temperature: -40°C ÷ +85°C
- Storage temperature: -40°C ÷ +125°C
- Packing: bulk (standard).

Tipo	T max. (mm)	D max. (mm)	H max. (mm)	d ± 0.05 (mm)	E ± 0.8 (mm)	L min. (mm)	c max. (mm)
05D	4.0 - 5.5	7.5	10.5	0.5	5	20	2.5
07D	4.5 - 6.0	10	12.5	0.5	5	20	2.5
10D	4.5 - 6.5	13.5	16	0.7	7.5	20	2.5
14D	4.5 - 6.5	17.5	20	0.7	7.5	20	2.5
20D	5.0 - 7.5	24	26.5	1.0	10	20	2.5