

VARISTORI
Varistore ø14 mm

 Codice Adimpex: **COT44150-R**

VARISTORI TSV-14D241K S 150VAC

Serie:TSV

p/n:TSV-14D241K 150VAC

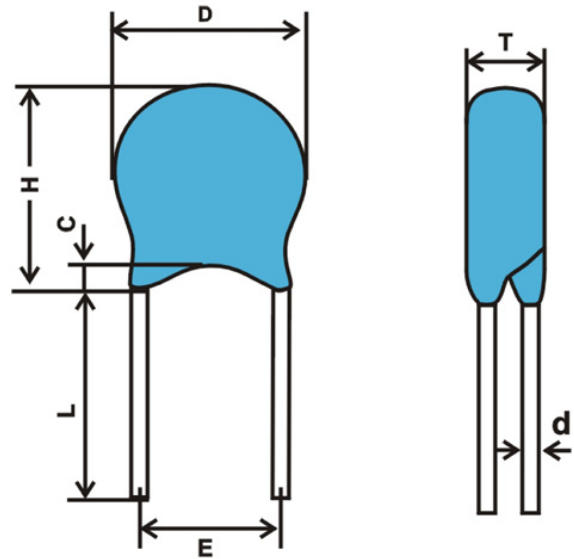

| Codice Adimpex | V _{eff} AC rms (V) | V _v @1.0 mA (V) |
|----------------|-----------------------------|----------------------------|
| COT44011 | 11 | 18 |
| COT44014 | 14 | 22 |
| COT44017 | 17 | 27 |
| COT44020 | 20 | 33 |
| COT44025 | 25 | 39 |
| COT44030 | 30 | 47 |
| COT44035 | 35 | 56 |
| COT44040 | 40 | 68 |
| COT44050 | 50 | 82 |
| COT44060 | 60 | 100 |
| COT44075 | 75 | 120 |
| COT44095 | 95 | 150 |
| COT44115 | 115 | 180 |
| COT44130 | 130 | 200 |
| COT44140 | 140 | 220 |

| Codice Adimpex | V _{eff} AC rms (V) | V _v @1.0 mA (V) |
|-----------------|-----------------------------|----------------------------|
| COT44150 | 150 | 240 |
| COT44175 | 175 | 270 |
| COT44190 | 190 | 300 |
| COT44210 | 210 | 330 |
| COT44230 | 230 | 360 |
| COT44250 | 250 | 390 |
| COT44275 | 275 | 430 |
| COT44300 | 300 | 470 |
| COT44320 | 320 | 510 |
| COT44350 | 350 | 560 |
| COT44385 | 385 | 620 |
| COT44420 | 425 | 680 |
| COT44460 | 460 | 750 |
| COT44485 | 485 | 780 |
| COT44510 | 510 | 820 |

CARATTERISTICHE

- Tolleranza: ± 10% (K)
- Temperatura di lavoro: -40°C ÷ +85°C
- Temperatura di immagazzinaggio: -40°C ÷ +125°C
- Confezione: sciolti (standard).

FEATURES

- Tolerance: ± 10% (K)
- Operating temperature: -40°C ÷ +85°C
- Storage temperature: -40°C ÷ +125°C
- Packing: bulk (standard).

| Tipo | T max. (mm) | D max. (mm) | H max. (mm) | d ± 0.05 (mm) | E ± 0.8 (mm) | L min. (mm) | c max. (mm) |
|------|-------------|-------------|-------------|---------------|--------------|-------------|-------------|
| 05D | 4.0 - 5.5 | 7.5 | 10.5 | 0.5 | 5 | 20 | 2.5 |
| 07D | 4.5 - 6.0 | 10 | 12.5 | 0.5 | 5 | 20 | 2.5 |
| 10D | 4.5 - 6.5 | 13.5 | 16 | 0.7 | 7.5 | 20 | 2.5 |
| 14D | 4.5 - 6.5 | 17.5 | 20 | 0.7 | 7.5 | 20 | 2.5 |
| 20D | 5.0 - 7.5 | 24 | 26.5 | 1.0 | 10 | 20 | 2.5 |