

VARISTORI
Varistore ø14 mm

 Codice Adimpex: **COT44017-R**

VARISTORI TSV-14D270K S 17VAC

Serie:TSV

p/n:TSV-14D270K 17VAC

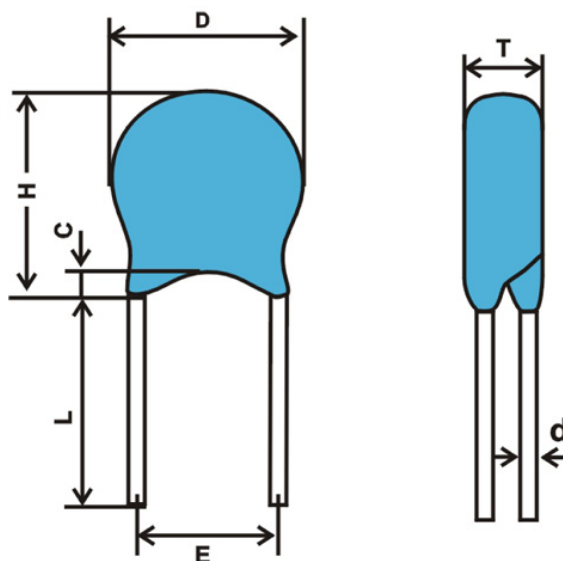

Codice Adimpex	V _{eff} AC rms (V)	V _v @1.0 mA (V)
COT44011	11	18
COT44014	14	22
COT44017	17	27
COT44020	20	33
COT44025	25	39
COT44030	30	47
COT44035	35	56
COT44040	40	68
COT44050	50	82
COT44060	60	100
COT44075	75	120
COT44095	95	150
COT44115	115	180
COT44130	130	200
COT44140	140	220

Codice Adimpex	V _{eff} AC rms (V)	V _v @1.0 mA (V)
COT44150	150	240
COT44175	175	270
COT44190	190	300
COT44210	210	330
COT44230	230	360
COT44250	250	390
COT44275	275	430
COT44300	300	470
COT44320	320	510
COT44350	350	560
COT44385	385	620
COT44420	425	680
COT44460	460	750
COT44485	485	780
COT44510	510	820

CARATTERISTICHE

- Tolleranza: ± 10% (K)
- Temperatura di lavoro: -40°C ÷ +85°C
- Temperatura di immagazzinaggio: -40°C ÷ +125°C
- Confezione: sciolti (standard).

FEATURES

- Tolerance: ± 10% (K)
- Operating temperature: -40°C ÷ +85°C
- Storage temperature: -40°C ÷ +125°C
- Packing: bulk (standard).

Tipo	T max. (mm)	D max. (mm)	H max. (mm)	d ± 0.05 (mm)	E ± 0.8 (mm)	L min. (mm)	c max. (mm)
05D	4.0 - 5.5	7.5	10.5	0.5	5	20	2.5
07D	4.5 - 6.0	10	12.5	0.5	5	20	2.5
10D	4.5 - 6.5	13.5	16	0.7	7.5	20	2.5
14D	4.5 - 6.5	17.5	20	0.7	7.5	20	2.5
20D	5.0 - 7.5	24	26.5	1.0	10	20	2.5