

VARISTORI

Varistore ø10 mm

Codice Adimpex: **COT40250-R**

VARISTORI TSV-10D391K S 250VAC

Serie:TSV

p/n:TSV-10D391K 250VAC

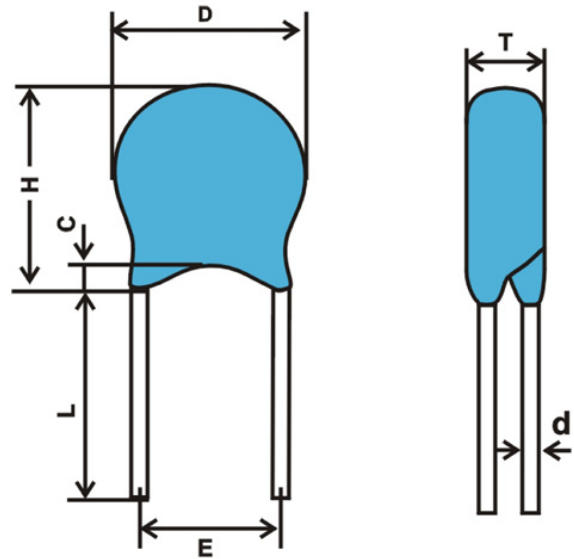

Codice Adimpex	V _{eff} AC rms (V)	V _v @1.0 mA (V)
COT40011	11	18
COT40014	14	22
COT40017	17	27
COT40020	20	33
COT40025	25	39
COT40030	30	47
COT40035	35	56
COT40040	40	68
COT40050	50	82
COT40060	60	100
COT40075	75	120
COT40095	95	150
COT40115	115	180
COT40130	130	200
COT40140	140	220

Codice Adimpex	V _{eff} AC rms (V)	V _v @1.0 mA (V)
COT40150	150	240
COT40175	175	270
COT40190	190	300
COT40210	210	330
COT40230	230	360
COT40250	250	390
COT40275	275	430
COT40300	300	470
COT40320	320	510
COT40350	350	560
COT40385	385	620
COT40420	425	680
COT40460	460	750
COT40485	485	780
COT40510	510	820

CARATTERISTICHE

- Tolleranza: ± 10% (K)
- Temperatura di lavoro: -40°C ÷ +85°C
- Temperatura di immagazzinaggio: -40°C ÷ +125°C
- Confezione: sciolti (standard).

FEATURES

- Tolerance: ± 10% (K)
- Operating temperature: -40°C ÷ +85°C
- Storage temperature: -40°C ÷ +125°C
- Packing: bulk (standard).

Tipo	T max. (mm)	D max. (mm)	H max. (mm)	d ± 0.05 (mm)	E ± 0.8 (mm)	L min. (mm)	c max. (mm)
05D	4.0 - 5.5	7.5	10.5	0.5	5	20	2.5
07D	4.5 - 6.0	10	12.5	0.5	5	20	2.5
10D	4.5 - 6.5	13.5	16	0.7	7.5	20	2.5
14D	4.5 - 6.5	17.5	20	0.7	7.5	20	2.5
20D	5.0 - 7.5	24	26.5	1.0	10	20	2.5