

VARISTORI
Varistore ø7 mm

 Codice Adimpex: **COT37050-R**

VARISTORI TSV-7D820K S 50VAC

Serie: TSV

p/n: TSV-7D820K 50VAC

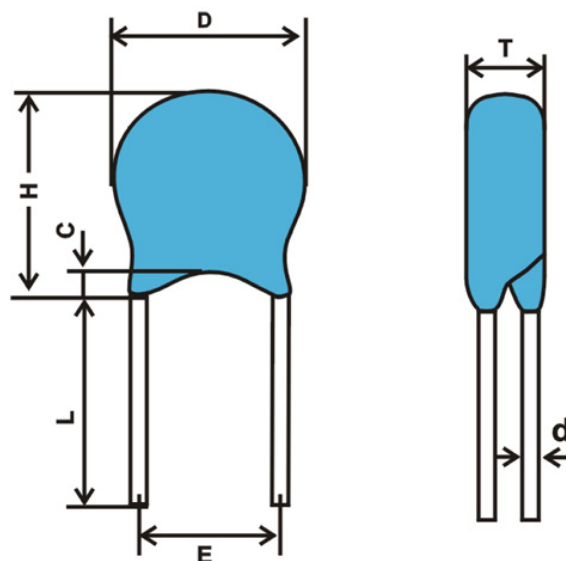

Codice Adimpex	V _{eff} AC rms (V)	V _v @1.0 mA (V)
COT37011	11	18
COT37014	14	22
COT37017	17	27
COT37020	20	33
COT37025	25	39
COT37030	30	47
COT37035	35	56
COT37040	40	68
COT37050	50	82
COT37060	60	100
COT37075	75	120
COT37095	95	150
COT37115	115	180
COT37130	130	200

Codice Adimpex	V _{eff} AC rms (V)	V _v @1.0 mA (V)
COT37140	140	220
COT37150	150	240
COT37175	175	270
COT37190	190	300
COT37210	210	330
COT37230	230	360
COT37250	250	390
COT37275	275	430
COT37300	300	470
COT37320	320	510
COT37350	350	560
COT37385	385	620
COT37420	420	680
COT37460	460	750

CARATTERISTICHE

- Tolleranza: ± 10% (K)
- Temperatura di lavoro: -40°C ÷ +85°C
- Temperatura di immagazzinaggio: -40°C ÷ +125°C
- Confezione: sciolti (standard).

FEATURES

- Tolerance: ± 10% (K)
- Operating temperature: -40°C ÷ +85°C
- Storage temperature: -40°C ÷ +125°C
- Packing: bulk (standard).

Tipo	T max. (mm)	D max. (mm)	H max. (mm)	d ± 0.05 (mm)	E ± 0.8 (mm)	L min. (mm)	c max. (mm)
05D	4.0 - 5.5	7.5	10.5	0.5	5	20	2.5
07D	4.5 - 6.0	10	12.5	0.5	5	20	2.5
10D	4.5 - 6.5	13.5	16	0.7	7.5	20	2.5
14D	4.5 - 6.5	17.5	20	0.7	7.5	20	2.5
20D	5.0 - 7.5	24	26.5	1.0	10	20	2.5

