

VARISTORI
Varistore ø5 mm

 Codice Adimpex: **COT35420-R**

VARISTORI TSV-5D681K S 420VAC

Serie:TSV

p/n:TSV-5D681K 420VAC

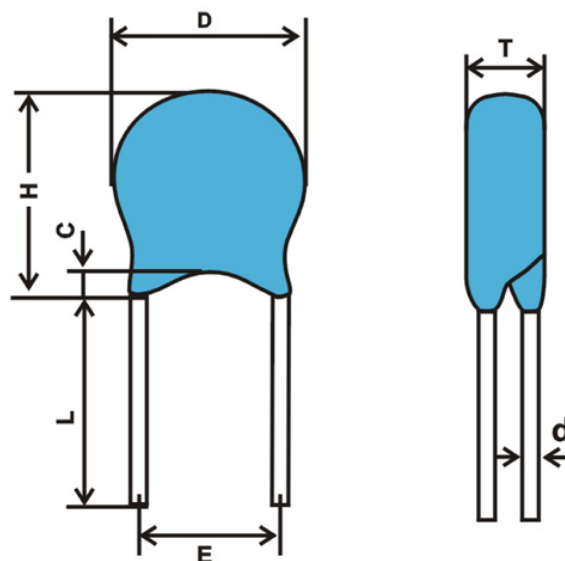

Codice Adimpex	V _{eff} AC rms (V)	V _v @1.0 mA (V)
COT35011	11	18
COT35014	14	22
COT35017	17	27
COT35020	20	33
COT35025	25	39
COT35030	30	47
COT35035	35	56
COT35040	40	68
COT35050	50	82
COT35060	60	100
COT35075	75	120
COT35095	95	150
COT35115	115	180
COT35130	130	200

Codice Adimpex	V _{eff} AC rms (V)	V _v @1.0 mA (V)
COT35140	140	220
COT35150	150	240
COT35175	175	270
COT35190	190	300
COT35210	210	330
COT35230	230	360
COT35250	250	390
COT35275	275	430
COT35300	300	470
COT35320	320	510
COT35350	350	560
COT35385	385	620
COT35420	420	680

CARATTERISTICHE

- Tolleranza: ± 10% (K)
- Temperatura di lavoro: -40°C ÷ +85°C
- Temperatura di immagazzinaggio: -40°C ÷ +125°C
- Confezione: sciolti (standard).

FEATURES

- Tolerance: ± 10% (K)
- Operating temperature: -40°C ÷ +85°C
- Storage temperature: -40°C ÷ +125°C
- Packing: bulk (standard).

Tipo	T max. (mm)	D max. (mm)	H max. (mm)	d ± 0.05 (mm)	E ± 0.8 (mm)	L min. (mm)	c max. (mm)
05D	4.0 - 5.5	7.5	10.5	0.5	5	20	2.5
07D	4.5 - 6.0	10	12.5	0.5	5	20	2.5
10D	4.5 - 6.5	13.5	16	0.7	7.5	20	2.5
14D	4.5 - 6.5	17.5	20	0.7	7.5	20	2.5
20D	5.0 - 7.5	24	26.5	1.0	10	20	2.5

