

CONDENSATORI Elettrolitici Radiali IN ALLUMINIO

Serie SG (105°C)

Codice Adimpex: **CI303316-R**

COND SG 33uF 16V 2.5NS 5x7

p/n:SG-330M1C0507-SA0

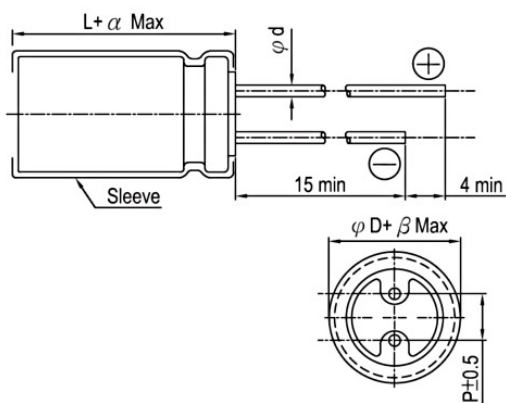

∅ D	4	5	6.3	8
P	1.5	2.0	2.5	3.5
∅ d	0.45	0.5		
α	1.0			
β	0.5			

Tensione (V)	16	25	35	50	63
Capacità (µF) ± 20%	Codice Adimpex ∅ D x L mA				
1					CI3.1063 4 x 7 11
2.2					CI3.2263 4 x 7 17
3.3				CI3.3350 4 x 7 18	CI3.3363 4 x 7 21
4.7			CI3.4735 4 x 7 22	CI3.4750 5 x 7 23	CI3.4763 5 x 7 26
10		CI301025 4 x 7 26	CI301035 4 x 7 25		CI301063 6.3 x 7 40
22	CI302216 4 x 7 29	CI302225 5 x 7 41	CI302235 5 x 7 44	CI302250 6.3 x 7 53	CI302263 8 x 7 70
33	CI303316 5 x 7 43	CI303325 6.3 x 7 53	CI303335 8 x 7 71	CI303350 8 x 7 76	
47		CI304725 6.3 x 7 65		CI304750 8 x 7 85	
100	CI311016 6.3 x 7 90	CI311025 8 x 7 125			
220	CI312216 8 x 7 146				

CARATTERISTICHE

- Piccole dimensioni
- Gamma di temperatura: -40°C ÷ +105°C
- Durata test: 1.000 ore

FEATURES

- Downsize
- Operating temperature range: -40°C ÷ +105°C
- Test time: 1.000 hours