

Potenzimetro Rotativo 16mm L15 TIPO F

Codice Adimpex: **BP750512-R**

POT RV16A-F-20-15F B20K *

Serie:RV16AF-20

p/n:RV16AF20-15F-B20K301

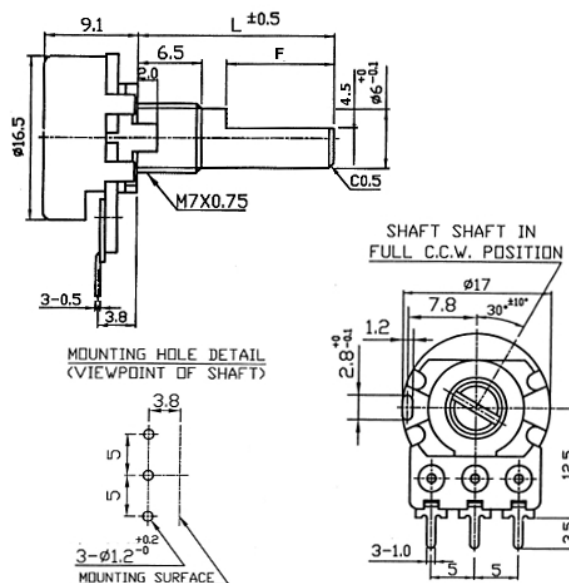
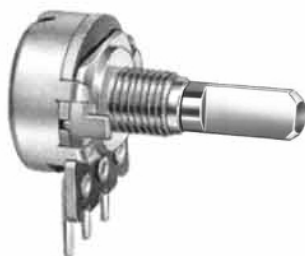

300° B LIN	Codice Adimpex	300° A LOG	Valore	Center click
BP045505	BP045805		1K	-
BP045507	BP045807		5K	-
BP045510	BP045810		10K	-
BP045512	BP045812		20K	-
BP045515	BP045815		50K	-
BP045520	BP045820		100K	-
BP045522	BP045822		200K	-
BP045526	BP045826		500K	-
BP045530	BP045830		1M	-
BP045540	BP045840		50K	✓
BP045542	BP045842		100K	✓