

COMMUTATORI ROTATIVI

Commutatore con albero in plastica e terminali da circuito

Codice Adimpex: **BL203004-R**

INTER ROT SR-IS-3/04-38-R-PC

Serie:SR2612F

p/n:SR2612F0304-38R0AD8N

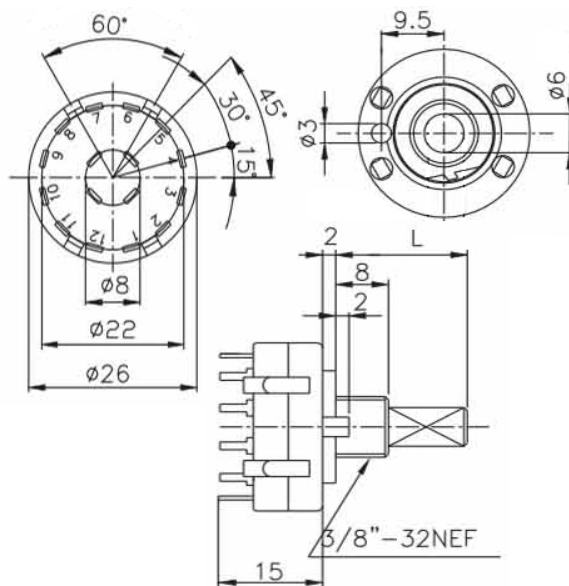

Codice Adimpex	n. poli	n. posiz.	Codice Adimpex	n. poli	n. posiz.	Codice Adimpex	n. poli	n. posiz.
BL200002	1	2	BL200009	1	9	BL202005	2	5
BL200003	1	3	BL200010	1	10	BL202006	2	6
BL200004	1	4	BL200011	1	11	BL203002	3	2
BL200005	1	5	BL200012	1	12	BL203003	3	3
BL200006	1	6	BL202002	2	2	BL203004	3	4
BL200007	1	7	BL202003	2	3	BL204002	4	2
BL200008	1	8	BL202004	2	4	BL204003	4	3

Lunghezza albero standard: 38 mm; su richiesta L= 15, 18, 38 mm

CARATTERISTICHE

- Albero: Ø6mm
- Portata: 125V AC a 0.3A
- Timing: shorting o non-shorting
- Angolo di cambio: 30°
- Resistenza di contatto: 50mΩ max.
- Resistance d'isolamento: > 100MΩ a 500V DC
- Rigidità dielettrica: 500V AC per 1 minuto
- Vita operativa (cicli): 10000

FEATURES

- Shaft: Ø6mm
- Rating: 125V AV at 0.3A
- Timing: shorting or non-shorting
- Changeover angle: 30°
- Contact resistance: 50mΩ max.
- Insulation resistance: > 100MΩ at 500V DC
- Withstand voltage: 500V AC for 1 minute
- Rotation life (cycles): 10000